

Some Notes on FM Sound Broadcasting Transmission Technology

Hans-Peter Hahn (hphahn@fm-stereo.com)
Ingenieurbüro für Akustik und Signalverarbeitung, Griesheim, Germany

The worldwide used FM transmission system is specified in the recommendation of the International Telecommunications Union ITU in document ITU-R BS.450 [1]. The following explanations refer to this recommendation, especially to the pilot-tone system with a maximum frequency deviation of +/-75 kHz.

With FM, the audio signal modulates the carrier frequency. The transmitted RF amplitude is constant and the wave is continuous. This is called Continuous Wave (CW).

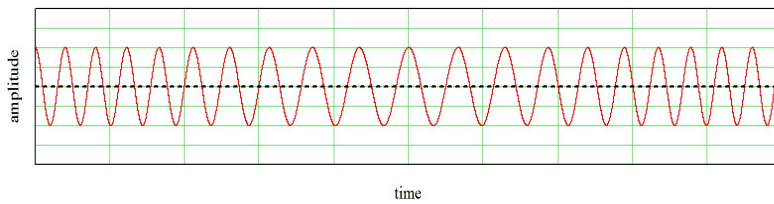

Figure 1

FM waveform (red) of constant amplitude, zero line hashed)

Example:

A single-tone message with amplitude A_m and frequency f_m

$$m(t) = A_m \cos(2\pi f_m t) = A_m \cos(\omega_m t)$$

should be transmitted. It therefore modulates a carrier frequency signal

$$c(t) = A_c \cos(2\pi f_c t) = A_c \cos(\omega_c t) \quad \text{with the carrier frequency } f_c \text{ and the phase } \omega_c t$$

in frequency, i.e. instead of an unmodulated frequency f_c we have an instantaneous frequency

$$f_i(t) = f_c + (\Delta f / A_m) m(t) \quad \text{with } \Delta f \text{ as the peak frequency deviation of the carrier frequency } f_c$$

Note:

The instantaneous frequency f_i varies in time between $f_c - \Delta f$ and $f_c + \Delta f$.

The instantaneous frequency deviation from f_c is proportional to the message signal $m(t)$. As a result, the information about the audio signal is carried in the instantaneous frequency or, if we take the reciprocal of frequency, in the distance between the zero crossings of the modulated signal.

The instantaneous phase is calculated by $\Theta_i(t) = 2\pi \int_0^t f_i(\tau) d\tau$.

$$\Theta_i(t) = 2\pi f_c t + (\Delta f / f_m) \sin(2\pi f_m t)$$

The modulated signal becomes

$$\begin{aligned} s_{FM}(t) &= A_c \cos[\Theta_i(t)] = A_c \cos[2\pi f_c t + (\Delta f / f_m) \sin(2\pi f_m t)] \\ &= A_c \cos[2\pi f_c t + \beta \sin(2\pi f_m t)] \end{aligned} \quad \text{(Eq. 1)}$$

with the FM modulation index $\beta = \Delta f / f_m$.

The FM signal in the time domain in Eq.1 can alternatively be described [2] as

$$s_{FM}(t) = A_c \sum_{n=-\infty}^{\infty} J_n(\beta) \cos(2\pi t [f_c + n f_m]) \quad (\text{Eq. 2})$$

with Bessel functions of the first kind $J_n(\beta)$ of order n . The sum results in 1, which means that $s_{FM}(t)$ has constant amplitude.

Since each cos-function corresponds to a line in the frequency spectrum, $s_{FM}(t)$ is composed of an infinite number of spectral lines, each with its amplitude defined by its Bessel function. We will see later that only a couple of dominant spectral lines have to be transmitted, and the rest has negligible contribution to the total power.

Superior noise immunity

The fluctuating amplitude of the received FM signal can be limited to a constant value. This limiting suppresses most of the noise, namely the AM component of the noise. The remaining interference in the RF phase component can be kept low if β is high, e.g. $\beta = 5$. In this case, the frequency modulation by the phase noise is much less than the frequency modulation by the audio signal. If, as it is here, the frequency spectrum of the frequency-modulated signal is clearly larger than the modulation-signal bandwidth, we have a spread spectrum technique.

This noise-rejecting effect was discovered by Edwin Howard Armstrong. He showed in 1933 that FM transmission of audio signals rejects the noise created by thunderstorms, lightning and electrical sparks (e.g., car ignition) much better than AM. Atmospheric and man-made noise are the most important sources for the limitation of the detection of radio signals.

For a transmission system to work in this way, the RF SNR (CNR) at the receiver input has to be translated into a much higher audio SNR after demodulation. If we define the demodulation gain G (also called improvement factor) as the SNR at the output of the demodulator related to the input CNR after bandlimiting in the RF path of the receiver, we find with FM [3]:

$$G_{FM} = \text{SNR}_{FM} / \text{CNR}_{FM} = 3\beta^2 (B/2W) \quad \text{with } W = \text{modulation-signal bandwidth} \quad (\text{Eq. 3})$$

with $B = \text{RF bandwidth}$

$$\text{With the Carson rule, which is } B = 2(1+\beta)W, \text{ we get} \quad (\text{Eq. 4})$$

$$G_{FM} = 3\beta^2(1+\beta) \quad \text{or}$$

$$\text{SNR}_{FM} = 3\beta^2(1+\beta)\text{CNR}_{FM} \quad (\text{Eq. 5})$$

FM demodulation gain G_{FM} increases with the square of the modulation index β for narrowband FM ($\beta \ll 1$) and with the third power of β with $\beta \gg 1$ for wideband FM.

With equal signal power before the demodulator and equal modulation-signal bandwidth after the demodulator, SNR_{FM} can be compared to SNR_{AM} according to [4] as

$$\text{SNR}_{FM} / \text{SNR}_{AM} = 9\beta^2/m^2 \quad (\text{Eq. 6})$$

with $m = \text{AM modulation index}$ and assuming coherent detection

With $\beta = 5$, FM has a 23.5 dB higher SNR than AM with a modulation index $m = 100\%$ (without pre-/deemphasis). Note that for modulation frequencies below 15 kHz (with the same amplitude/frequency deviation), the modulation index increases above 5. The improvement over AM becomes 33 dB at a modulation frequency of 1 kHz.

With $\beta = 5$, FM has an inherent noise suppression in contrast to amplitude modulation-based transmission systems, such as AM, DSB, OFDM. Therefore, FM is particularly suitable in frequency bands with higher electromagnetic interference levels (man-made noise at 100 MHz is about 10 dB higher than at 200 MHz). [5] and [6] give information about noise sources, their frequency dependence in various environments.

(Note: Coded digital transmission systems using digital modulation like OFDM use subsequent forward error correction techniques to reduce errors in the received bitstream at the expense of data rate and transmission time.)

FM threshold

FM reception is associated with a threshold. Below a certain CNR the audio SNR decreases rapidly, and at some point the noise becomes the main signal component at the receiver output. Unlike digital radio with its cliff effect (below a threshold, the signal is lost immediately), FM fails in a gradual way. Reception several dB below the threshold is still possible, but with reduced audio quality. The FM threshold depends on the FM modulation index β . With $\beta = 5$ we get a threshold of about 11 dB CNR (10 dB with unmodulated carrier) with a receiver bandwidth according to the Carson rule.

$$\text{SNR}_{\text{FM}} = 3\beta^2(1+\beta)\text{CNR}_{\text{FM}} \quad \text{Equation 5 is valid above the FM threshold}$$

A closer look reveals there are 2 thresholds. As shown in Fig. 2, above the first threshold, SNR is linear with CNR.

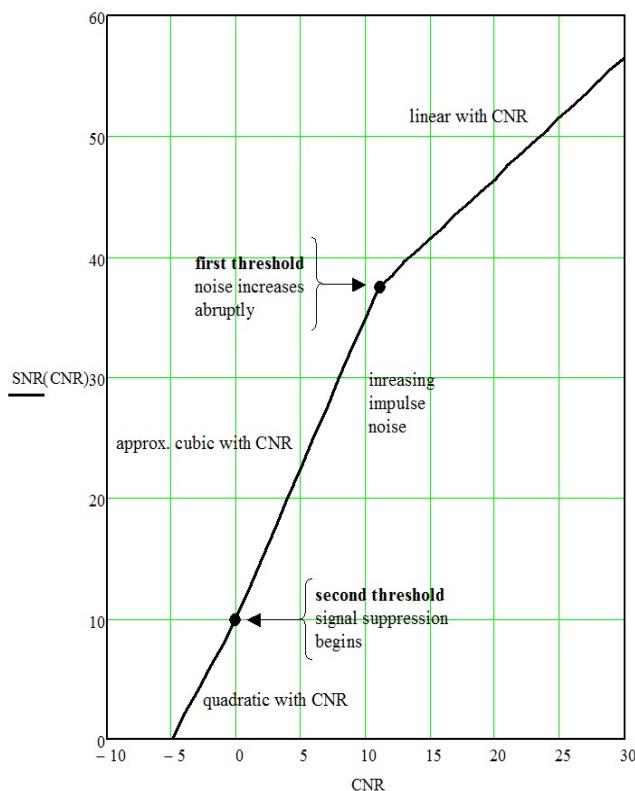

Figure 2

SNR vs CNR with first and second FM threshold [7], represented in simplified form as polygons. The actual transitions are continuous.

Around the first threshold individual audible clicks arise. Below the first threshold, SNR decreases by approximately 30 dB/decade of CNR because of the increasing click rate. This results in a sputtering sound.

As shown in Fig. 3, clicks in the demodulated audio signal are caused by additive noise resulting in nearly complete loss of the carrier signal (path 2) or in $\pm 2\pi$ phase excursions of the carrier signal (path 1). Phase excursions of multiples of $\pm 2\pi$ also lead to clicks.

Figure 3 FM locus curve of unmodulated carrier with amplitude A_c at high CNR (left), low CNR (mid), and demodulated signal (right) [7]

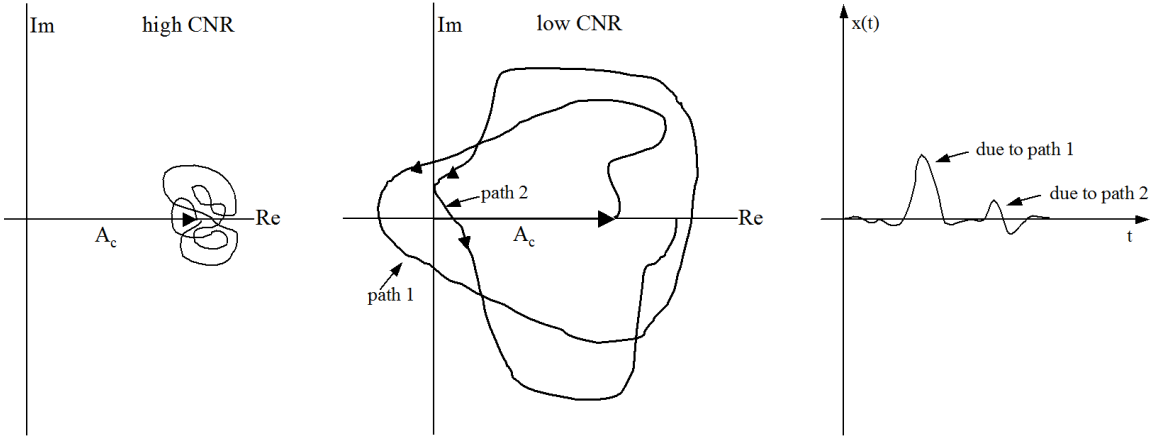

Below the second threshold, SNR falls quadratic with CNR, and the noise becomes the dominant signal. In [7] it is shown that at the takeover point, the rms value of the noise is about 1/3 of the amplitude of the demodulated signal. According to [8] the SNR (without deemphasis) around the first FM threshold for sinusoidal modulation can be estimated by

$$SNR = G_{FM}CNR / (1 + (8G_{FM}/\beta\pi)CNR e^{-CNR}) \quad \text{with } G_{FM} = 3\beta^2(1+\beta)$$

Fig. 4 shows the random FM noise waveform demodulated, with a carrier above threshold; Fig. 5 shows the noise demodulated without a carrier signal. Both have the same rms level.

Figure 4 FM random noise with carrier above threshold (after deemphasis 50μs)

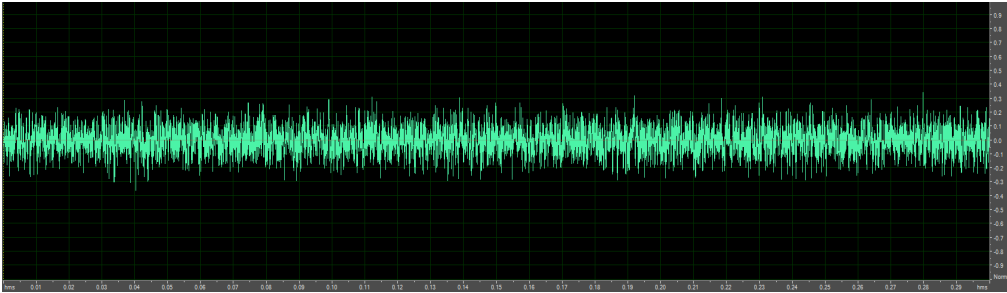
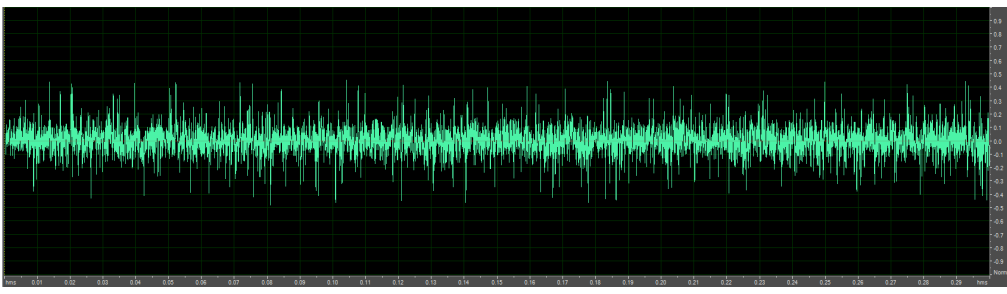

Figure 5 FM noise without carrier (below threshold) with clicks (after deemphasis 50μs)



Threshold extension

There are various threshold extension techniques, all of which reduce the effective RF/IF predetection bandwidth and thus noise power. These include the tracking PLL and the FM feedback (FMFB) technique. Improvements in SNR are about 2-5 dB with a β of 5. Other conceivable techniques attempt to reduce the interference in the already demodulated signal without affecting the useful signal.

Capture effect

If 2 signals (2 radio transmitters or a signal received over several paths, such as with multipath reception) are received on the same channel, the stronger signal is demodulated and the weaker signal is suppressed. The limiting amplifier and/or the FM demodulator is responsible for this. The effect already occurs at level differences < 0.5 dB. A typical value of an FM tuner is 1.5 dB.

RF bandwidth

The Carson rule (Eq. 4) can also be represented as $B = 2(\Delta f + f_m)$. For modulation frequencies of 20 Hz - 15 kHz and a fixed peak deviation $\Delta f = \pm 75$ kHz, the Carson bandwidth ranges between 150 - 180 kHz. At higher values of β , the bandwidth shows a low dependence from the modulation frequency. Therefore, FM is sometimes called a constant bandwidth system.

At the receiver site, a limitation of the bandwidth is necessary to limit the noise power and to attenuate unwanted adjacent channel signals. The FM signal in Eq.2 is

$$s_{FM}(t) = A_c \sum_{n = -\infty}^{\infty} J_n(\beta) \cos(2\pi t [f_c + n f_m])$$

The Carson rule, which defines the RF bandwidth to $2(1+\beta)$ times the modulation frequency, covers at least 98% of the power. The cut-off frequency components contribute to less than 2% of the power. This is because the magnitude of the Bessel functions decreases with increasing order n .

In case of a single-tone modulation with frequency $f_m = W$, the Carson rule states the number of significant discrete spectral lines in an FM spectrum as $2n=2(1+\beta)$, not including the carrier frequency. For $f_m = 15$ kHz and $\beta = 5$, we get 12 spectral lines plus a carrier frequency with a frequency spacing f_m within bandwidth $B = 180$ kHz. With multitone modulation, the spectrum gets more complicated. For more than 2 tones, the estimate of the FM bandwidth should be based on the Carson rule, with W for the base bandwidth ($W=53$ kHz and $\beta=1.27$ in the stereo case).

Note: Restricting the bandwidth generates an additional AM, but this can be suppressed by an amplitude limiter in the receiver.

Figure 6

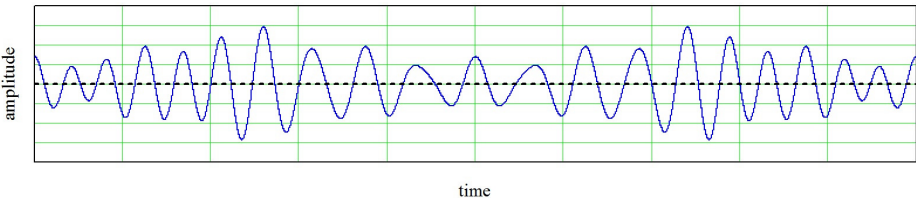

FM waveform with AM due to bandwidth limiting

Limiting the RF bandwidth, i.e. linear filtering in the receiver, also creates nonlinear distortion of the demodulated signal (note that FM is not LTI). It can be shown that a symmetrical shape of a bandwidth limitation results in a mainly cubic distortion of the modulation signal. The cubic distortion k_3 of a modulation frequency f_m can be calculated according to [9] as

$$k_3(\beta, n) = (6/\beta)(J_{n-2}J_{n+1} + J_{n-1}J_{n+2} + J_nJ_{n+3}) \quad (\text{Eq. 7})$$

with RF bandwidth $B = 2nf_m$, with $\beta = \Delta f/f_m$, and without consideration of a pre-/deemphasis.

Calculation of k_3 for $\beta = 5$:

n = 6	k_3 (15 kHz@dev75kHz) = 3.06 %	B = 180 kHz	(Carson rule: n = $\beta + 1$)
n = 7	k_3 (15 kHz@dev75kHz) = 0.66 %	B = 210 kHz	
n = 8	k_3 (15 kHz@dev75kHz) = 0.095 %	B = 240 kHz	
n = 9	k_3 (15 kHz@dev75kHz) = 0.01 %	B = 270 kHz	

Calculation of k_3 for $\beta = 3$:

n = 4	k_3 (15 kHz@dev45kHz) = 4.57 %	B = 120 kHz	(Carson rule: n = $\beta + 1$)
n = 5	k_3 (15 kHz@dev45kHz) = 0.74 %	B = 150 kHz	
n = 6	k_3 (15 kHz@dev45kHz) = 0.069 %	B = 180 kHz	
n = 7	k_3 (15 kHz@dev45kHz) = 0.004 %	B = 210 kHz	
n = 8	k_3 (15 kHz@dev45kHz) = 0 %	B = 240 kHz	
n = 9	k_3 (15 kHz@dev45kHz) = 0 %	B = 270 kHz	

The calculation shows that for a given bandwidth, k_3 drops rapidly with even a small reduction of the FM deviation. Limiting the audio level, as it is done in the signal processing before FM modulation, is a condition for low distortion.

Nevertheless, some receivers reduce the IF bandwidth in poor reception conditions, resulting in some tolerated distortion.

In practice, IF filters don't have a brickwall characteristic but a certain roll-off.

The rated bandwidth usually refers to the -3 dB or -6 dB points (3 dB or 6 dB bandwidth).

With multitone modulation, third-order intermodulation products can fall into the used modulation frequency range. Important are the intermodulation products of 2 frequencies:

$(2 \cdot f_2 - f_1)$ and $(2 \cdot f_1 - f_2)$. The noise reduction method described in [10] suppresses all non-linear products at frequencies of the difference signal which are not contained in the sum signal.

Usually, amplitude limiting follows bandwidth limiting. Between the bandpass filter and the amplitude limiter, any filter shape can be used as long the filter is linear-phase and the introduced AM can be removed by the amplitude limiter. The linear-phase condition keeps the distance between the zero crossings of the modulated signal.

It should be noted that either a too narrow IF bandwidth or an audio signal causing an FM deviation $> \pm 75$ kHz, or causing an MPX power > 0 dB_r (see section "Regulation of Telecommunication"), can lead to AM as shown in Fig. 6. If the received signal is also weak, it can fall short of the FM threshold and the signal can be lost.

Peak limiter, studio-transmitter link (STL), stereo encoder

As a rule, the audio signal is limited to a peak value in order not to exceed the specified peak deviation later during FM modulation. For this purpose, the transmission chain as a whole after the limiter must not change the time representation of the signal, that is:

- The bandwidth must be larger than that of the peak limiter output signal, and the phase must be linear within the frequency range of the amplitude limited signal. This applies to amplifiers, the STL and, if applicable, the stereo encoder, whether digital or analog.
- Perceptual audio encoding is unsuitable because it changes the signal in the time representation and leads to increased peak values.

FM exciter and transmitter

Modern FM exciters are digital. As far as the FM transmitter is concerned, the amplifier does not have to be linear, since only frequency changes contain the transmitted information.

The use of non-linear amplifiers (e.g., class C and class D/E amplifiers) allows a higher efficiency of the transmitter compared to linear operation. The efficiency (AC power in to RF power out) of larger FM transmitters is about 70 - 75 %.

The specifications for FM transmitters are regulated differently depending on the country.

Polarization

Horizontal, vertical and mixed polarizations were investigated in [11].

Horizontal polarization offers about 10 dB more protection against car ignition noise with fixed reception [5]. Different types of polarization are used worldwide.

Regulation of Telecommunication, FM frequency management and network planning

The regulatory authority in the U.S.A. is the FCC (Federal Communications Commission).

Frequency management assures that for a planned service area of a transmitter, unwanted signals of the same or adjacent and alternate channels/frequencies from other transmitters are small enough. Otherwise, co-channel interference (CCI) or adjacent-channel interference (ACI) could occur. Planning standards are recommended by the ITU in the document ITU-R BS412-9 [12]. The document includes limits for the frequency deviation and the power of the MPX signal, as well as protection ratios (CCI, ACI) for multiple- and single-frequency networks.

The determination of protection ratios is explained in recommendation ITU-R BS.641 [13].

General network planning is described in [14]. This document includes information about wave propagation, field strength prediction, protection ratios (ACI, CCI) and coverage.

The impact of audio signal processing and compression techniques (that affect the MPX power) on the interference to other FM stations is investigated in [15].

Channel spacing

Common channel spacings are 100 kHz and 200 kHz (U.S.A.). As far as the Carson rule is concerned, with a channel spacing of 200 kHz, two signals can theoretically be separated with

a limitation of the outer bandwidth. At a channel spacing of 100 kHz, there is a significant overlap of the spectra. Network planning and frequency management take this into account when protecting service areas. The geographical location and radiated power of a transmitter also play a role here.

Multipath interference

With multipath reception, the electromagnetic wave reaches the receiving antenna via reflections and/or directly (LOS = line of sight). Each path has its own time delay and amplitude. The superposition of the waves at the receiving antenna generates an amplitude modulation and a phase deviation of the main FM signal. While the AM component can be effectively suppressed by the amplitude limiter of the receiver, the phase modulation is indistinguishable from the wanted FM modulation. It leads to audible distortion of the audio signal after FM demodulation. Modern receivers blend to mono in this case.

A special case is wave cancellation. Here, a destructive interference of the waves can lead to a severe decrease in field strength, and in some cases the signal is lost. Diversity receivers can mitigate these problems, e.g. by RDS. For more details see "mobile reception".

Multipath distortion has been investigated in [16]. Information about the results and conclusions of listening tests with multipath simulators can be found in [14].

Multipath distortion with stereo reception is higher than with mono reception.
(see also: Mobile reception)

Pre-/Deemphasis

Deemphasis at the receiving side compensates for the preemphasis on the transmission side, so that the audio signal is not changed when viewed over the entire transmission chain. According to [1] the pre-/deemphasis is used with time constants τ of 50 μ s or 75 μ s in different regions of the world.

At the receiving side, FM demodulation takes place. Above the FM threshold, the demodulated FM noise increases with frequency (see Fig. 8). In [17] it is shown, that with deemphasis, the SNR over the entire audio bandwidth increases by the deemphasis gain G_{de} according to

$$G_{de} = 10\log([\gamma]^3/3[\gamma-\arctan \gamma]) \quad (\text{Eq. 8})$$

with $\gamma = 2\pi\tau 15\text{kHz}$

with the deemphasis time constant τ

$G_{de} = 13.2 \text{ dB at } 75\mu\text{s}$

$G_{de} = 10.2 \text{ dB at } 50\mu\text{s}$

At the studio/transmitter site the preemphasis emphasizes higher frequencies of the audio signal. Since speech and music have fewer high-frequency components, preemphasis allows for adjustment to a flat audio spectrum. Care must be taken to ensure that the peak-to-peak value of the audio signal after preemphasis does not exceed the permissible FM deviation. This is usually achieved by dynamic processing before or in the stereo encoder.

Modern music often contains a lot of high-frequency energy. In order to avoid that the dynamic processing reduces the preemphasis to a large extent and produces a sound image with understated treble, a certain amount of leeway is usually reserved for the preemphasis.

FM stereo

The FM stereo transmission system is described in ITU-R BS.450 [1].

It recommends a 19 kHz pilot-tone injection level of 8-10% of the maximum deviation. This means that the pilot tone can already be recovered at the FM threshold.

The amplitudes of the sum signal $(L+R)/2$ and the DSBSC modulated difference signal $(L-R)/2$ must not exceed 90% of the maximal amplitude of the MPX-signal corresponding to the maximum frequency deviation. Therefore, the sum and difference signals must be reduced in amplitude for the MPX signal to comply with the maximum frequency deviation.

The following also applies to the U.S.A.: Additional sub-carriers or supplementary signals may increase the maximum frequency deviation to 110% or ± 82.5 kHz.

The transmission bandwidth increases with stereo as the modulation bandwidth is now 53 kHz.

According to the Carson rule (3) and with a frequency deviation of 68.25 kHz (pilot tone 6.75 kHz) we get an RF bandwidth $B = 242.5$ kHz.

At the transmitter site, the left and right audio signals are stereo encoded. The audio signals L and R are matrixed. The resulting sum signal $(L+R)/2$ is added to the pilot tone signal. The difference signal $(L-R)/2$ after matrixing modulates a frequency of 38 kHz, which is in phase with the pilot tone. The modulation is double side band suppressed carrier. The DSBSC signal is added to the sum signal and the pilot tone to give the frequency multiplex signal MPX.

Fig.8 shows a simplified signal processing.

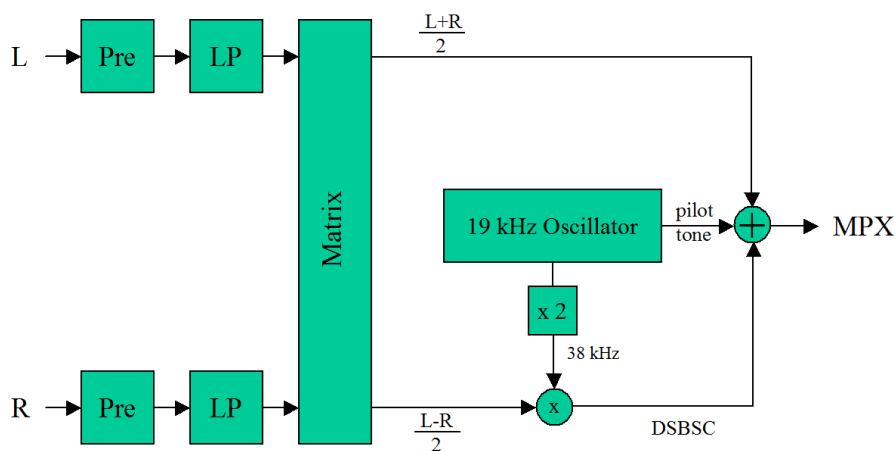

Figure 7
stereo encoder

with De = deemphasis, LP = 15 kHz lowpass filter

The MPX signal modulates the RF carrier signal of an FM transmitter.

At the receiver site, the RF signal is FM demodulated to get the MPX signal.

Thereby, the frequency constant noise power density in the RF- or IF-range is converted into a frequency-proportional noise voltage-density as shown in Fig. 8. This is equivalent to a parabolic noise power density [18].

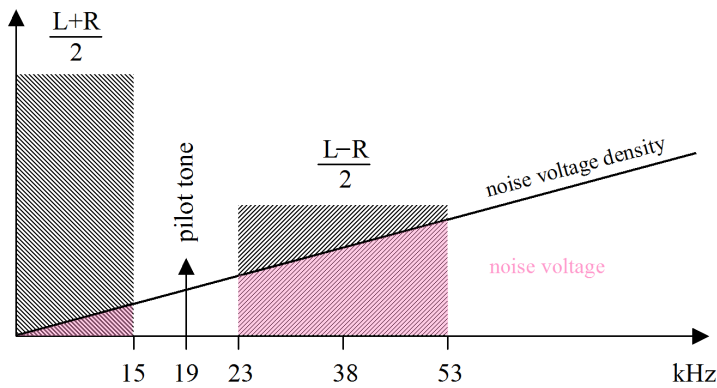

Figure 8

MPX-spectrum:
noise voltage density and noise voltage (pink area), sum and difference signals (shaded)

A stereo decoder recovers the left and right audio signals. Fig. 9 shows a simplified signal processing.

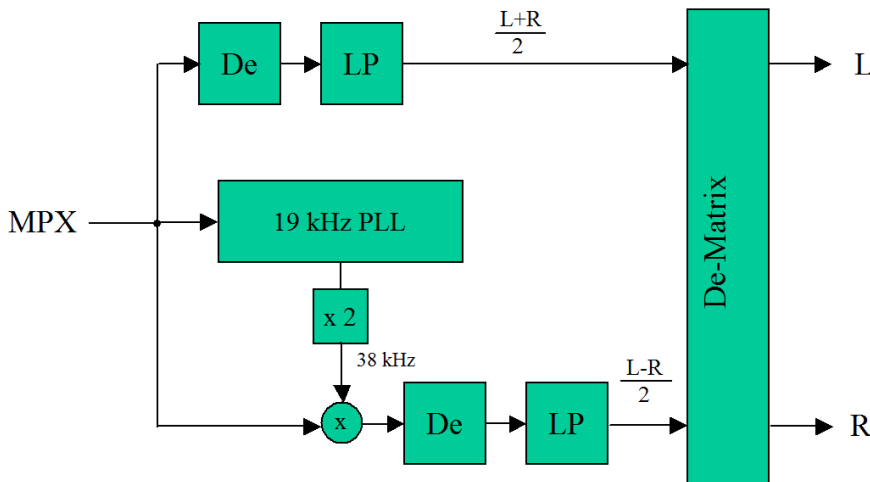

Figure 9

stereo decoder

with De = deemphasis, LP = 15 kHz lowpass filter

Figure 8 shows that the difference signal $(L-R)/2$ between 23 and 53 kHz contains significantly more noise (pink area) than the sum signal $(L+R)/2$, which only reaches up to 15 kHz. The stereo decoding process as described above maps the noise into the baseband of the left and right channels. Thus, in the stereo case the audio SNR is considerably less than in the mono case where only the $(L+R)/2$ signal is decoded.

The noise voltage density increases in proportion to frequency. For mono reception up to 15 kHz, the deemphasis nearly compensates for the noise above the corner frequency of the deemphasis network of 2.12 kHz (75 μ s) and 3.18 kHz (50 μ s), as shown in Fig.10 (red curves). Just above the FM threshold and far enough below the maximum achievable SNR, the stereo noise is 22.2 dB above mono noise, calculated over the entire audio band up to 15 kHz with a deemphasis of 75 μ s. The noise spectrum of stereo noise is different from the mono noise spectrum. Fig. 10 shows the calculated noise spectrum of the signals L or R after mono and stereo decoding and deemphasis just above the FM threshold:

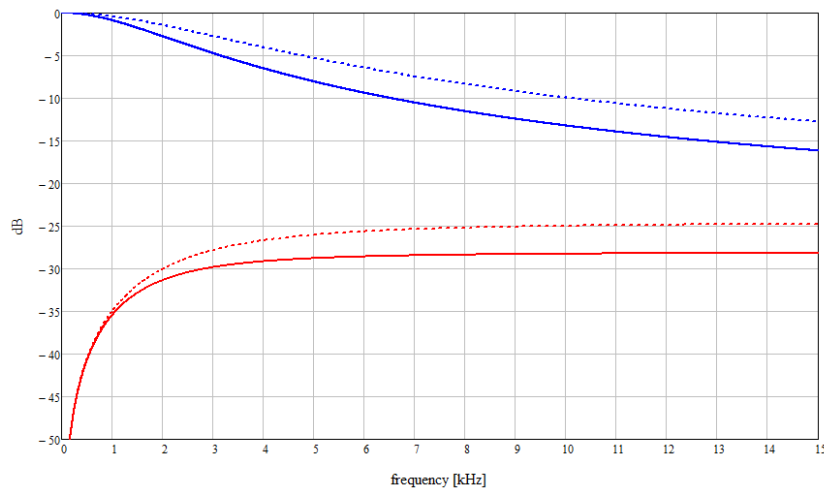

Figure 10

Noise spectrum after stereo decoding (blue) and mono decoding (red), after deemphasis $75\mu\text{s} / 50\mu\text{s}$ (dotted), adjusted for 0 dB stereo noise at DC

In the stereo case, the lower (LSB) and upper sidebands (USB) of the (L-R) signal are subjected to deemphasis. LSB and USB noise have different spectra and are added after stereo decoding. As a result, the noise of a stereo-decoded signal differs from mono noise depending on the frequency. Stereo noise emphasizes lower audio frequencies.

Fig. 11 shows the mono gain $[\text{SNR}_{\text{mono}} - \text{SNR}_{\text{stereo}}]$ in dB just above the FM threshold. At 1 kHz the difference is 34.6 dB; at 15 kHz we see a gain of 12.0 dB. The mono gain represents the frequency-dependent noise reduction that we obtain when we switch the receiver from stereo to mono at the expense of a total loss of stereo separation. The noise reduction method described in [10] approximates these values while maintaining stereo channel separation and frequency response. In optimal reception conditions, the FM-specific noise is dominated by the inherent noise of the audio stages of the receiver. At this point, the monogain typically reduces to a frequency-flat 2-5 dB (depending on the receiver; see e.g. Fig. 12).

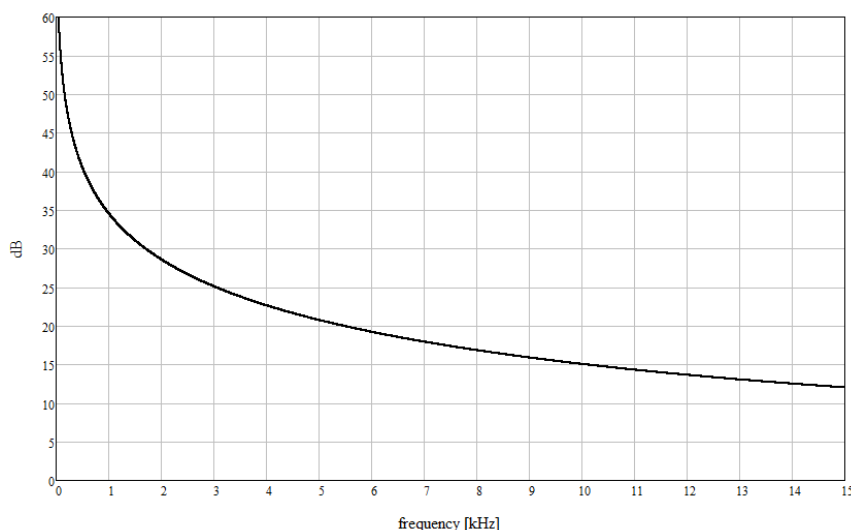

Figure 11

Mono gain in SNR over stereo, just above the FM threshold

FM stereo SNR calculations (RMS unweighted)

The audio signal to noise ratio according to Eq. 5 is $SNR_{FM} = 3\beta^2(1+\beta)CNR_{FM}$.

In the mono case with $\beta=5$ and at the threshold level of 11 dB CNR_{FM} , we get an $SNR_{FM} = 37.5$ dB (50.5 dB after 75 μ s deemphasis), related to a peak deviation of $\Delta f = \pm 75$ kHz.

In the case of stereo, we take the mono SNR related to a peak deviation of 67.5 kHz (the pilot tone takes 10% of the peak deviation) of 49.6 dB after 75 μ s deemphasis and subtract the above mentioned 22.2 dB to get the stereo SNR of 27.4 dB.

With a typical HiFi FM receiver, a 50 dB mono quieting can be achieved with an antenna input level of 20 dBf in a random noise environment.

To sum up, above the FM threshold we get:

$SNR_{mono} \geq 50.5$ dB after 75 μ s deemphasis related to $\Delta f = \pm 75$ kHz [without pilot tone].

$SNR_{mono} \geq 49.6$ dB after 75 μ s deemphasis related to $\Delta f = \pm 67.5$ kHz [stereo transmission and mono reception].

$SNR_{stereo} \geq 27.4$ dB after 75 μ s deemphasis related to $\Delta f = \pm 67.5$ kHz.

Fig. 12 shows the FM quieting curves of a HiFi tuner with a pre-/deemphasis of 50 μ s. For a 75 μ s pre-/deemphasis, the mono (stereo) noise curve shifts down by 3 dB (1.6 dB). FM threshold occurs at an RF level of about 1 μ V. Mono SNR at threshold is about 50 dB with 75 μ s systems. The noise reduction method described in [10] reduces the stereo noise to mono level (pink curve) while maintaining stereo channel separation and frequency response.

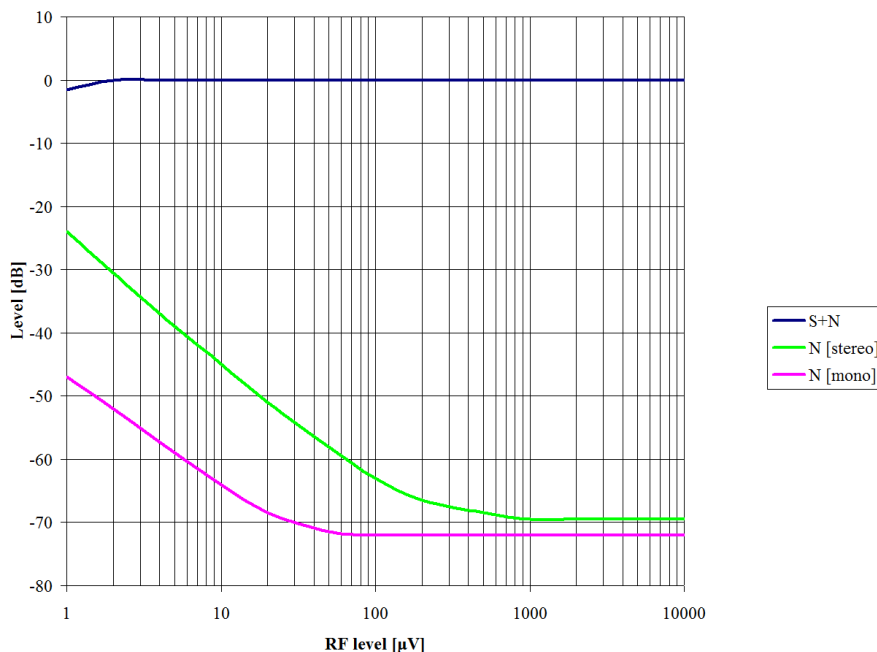

Figure 12

FM quieting curves of a HiFi tuner with a deemphasis of 50 μ s, related to a frequency deviation of ± 75 kHz = 0 dB.

Stereo channel separation

A high stereo channel separation requires a flat magnitude response and a linear phase in the MPX band of the transmission chain. Otherwise, the sum and difference signals cannot be recovered precisely and the de-matrixing creates stereo crosstalk.

A sufficiently large RF/IF bandwidth helps in this respect. Linear phase can be achieved by the use of an FIR filter in the receiver to define the bandwidth.

A precise pilot tone recovery as part of the stereo decoder ensures a coherent demodulation of the DSBSC signal. If there is a phase difference of the 38 kHz signal (2×19 kHz) to the DSBSC signal, the difference signal will have less amplitude after demodulation, and de-matrixing will transform this into less stereo separation. In a PLL stereo decoder, the noise induced phase jitter of the reconstructed 38 kHz signal is influenced by the bandwidth of the 19 kHz PLL. Common stereo decoder variants achieve a stereo separation of 45-55 dB under ideal reception conditions. The pilot tone can be detected within 25 ms (typical).

Mobile reception

Mobile reception is prone to signal fluctuations. The reasons for this include a field strength dependent on location, shadowing by obstacles, flat fading because of multipath reception, or changing the direction of travel. The antenna pattern is not omnidirectional to a certain degree. Just as amplitude noise can be removed, signal fluctuations due to channel degradation can also be removed. This makes FM ideal for use in mobile applications where signal levels constantly vary.

When the signal becomes weak, a common strategy of a stereo receiver is to reduce noise at the expense of stereo separation. This is done by reducing the level of the difference signal $(L-R)/2$ in the stereo decoder before de-matrixing. Some receivers also use this strategy for multipath reception.

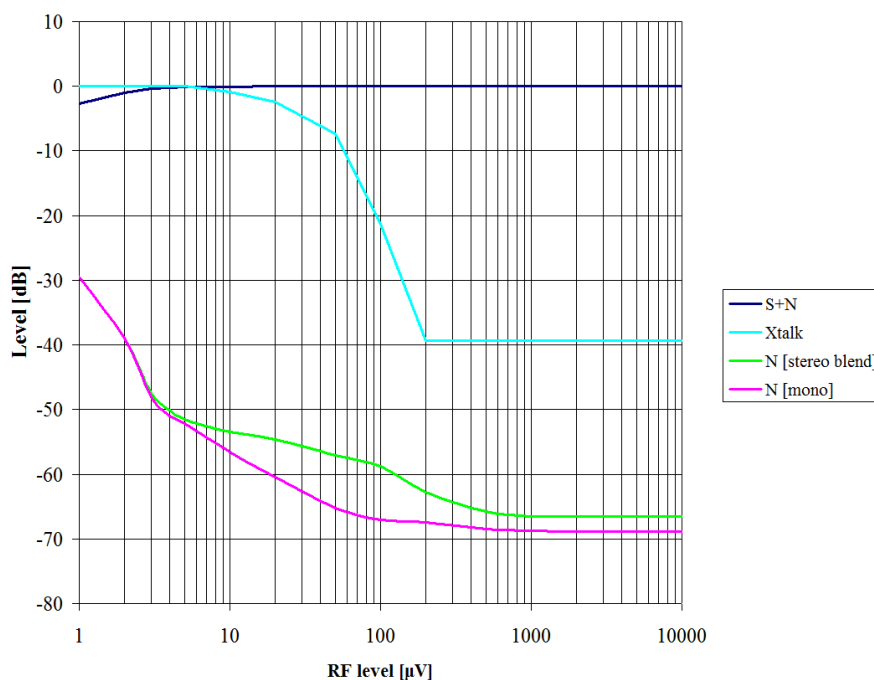

Figure 13

FM quieting curves of a car radio with a deemphasis of $50 \mu\text{s}$, related to a frequency deviation of $\pm 75\text{kHz}$ = 0 dB.

The receiver reduces the stereo separation (blue) at low RF levels to bring the stereo noise (green) closer to the mono noise (pink).

Fig. 14 shows a recording from a car radio while driving. Stereo separation is reduced 4 times to mono due to the weak RF signal. As long as the signal is not completely lost, the SNR can be kept at a reasonable level. With total signal loss, the entire audio signal is usually muted.

Figure 14 sum signal (red) and difference signal (blue)

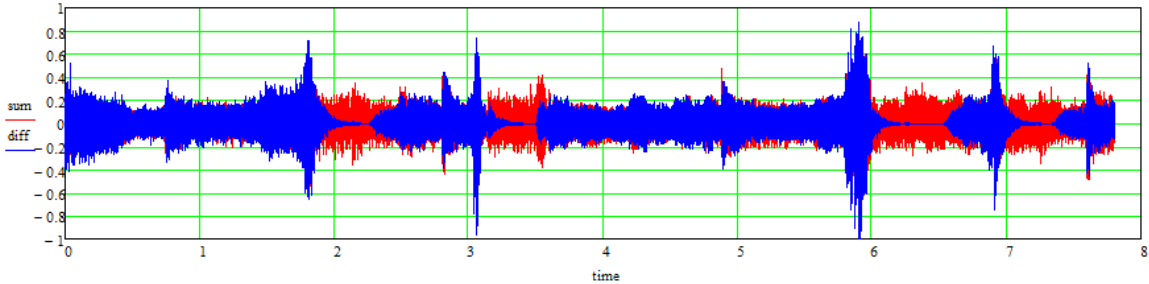

If the signal processing method described in [10] were used in a receiver, the reduction of the difference signal described above would not take place. Full stereo separation could be maintained and the stereo SNR could be improved to mono level

Multipath reception

Sometimes the signal is not only received directly, but over several paths (via reflections and/or direct path). This multipath reception causes interference. Multipath interference can lead to frequency-selective fading (high delay spread) or to flat fading (low delay spread). While flat fading creates a decrease in the RF level of the entire signal spectrum and the audio SNR gets worse, in the case of frequency-selective fading, signal power is still there, but audio distortion products arise. The distortion is highly correlated with the desired audio signal unlike random noise, which is usually perceived as separate interference from the desired audio signal.

If a received multipath signal is comprised of *i* signals with individual time delays τ_i , the maximum and minimum delay of significant components define the time delay spread

$$T_d = \max (\tau_i) - \min (\tau_i)$$

The coherence bandwidth B_{COH} is defined as the bandwidth over which the channel can be considered "flat".

B_{COH} is a measure of the frequency difference (bandwidth) by which 2 sinusoidal signals must differ on average in level. The coherence bandwidth, dependent on the cross correlation of the 2 frequency components, can be defined as

$$B_{COH} = 1 / (5T_d) \quad \text{for a cross-correlation of 0.5}$$

$$B_{COH} = 1 / (50T_d) \quad \text{for a cross-correlation of 0.9}$$

B_{COH} is dependent on the nature of the environment of the receiving site (e.g. buildings and their reflection properties). The value is location-dependent and can therefore vary for mobile reception. Typical values of delay spread (measured at 900 MHz, roughly transferable to 100 MHz) and their equivalent coherent bandwidths (50%) are

urban - 3000 ns	$B_{COH} = 67 \text{ kHz}$	(high delay spreads in the order of $50\mu\text{s}$ can be observed in mountainous regions)
suburban - 500 ns	$B_{COH} = 400 \text{ kHz}$	
indoor - 100 ns	$B_{COH} = 2 \text{ MHz}$	
open areas - 20 ns	$B_{COH} = 10 \text{ MHz}$	

If the signal bandwidth is smaller than B_{COH} , all spectral components have approximately the same amplitude and linear phase. In this case, destructive interference will lead to a significant loss (e.g. 30 dB) in signal level over the entire signal bandwidth. This is called flat fading. Sometimes flat fading lets the signal level drop below the FM threshold. In this case, threshold extension techniques or diversity techniques can improve the audio quality. If the signal bandwidth is larger than B_{COH} , only parts of the signal spectrum show collapses. This is called frequency-selective fading. With an FM transmission bandwidth of approximately 200 kHz, we can expect frequency-selective fading to happen in urban areas. Indoors and in suburban and open areas, we can expect flat fading. Note that digital transmission systems like HD-Radio are subject to the same dependency.

In the FM receiver, the amplitude limiter effectively removes the amplitude distortions of the FM signal caused by multipath fading. The remaining phase distortion mainly affects the higher modulation frequencies, i.e. the difference signal $(L-R)/2$. The noise reduction method described in [10] suppresses all frequencies of the difference signal which are not contained in the sum signal. Therefore, multipath interference is reduced to mono quality.

(Note: Digital transmission systems using digital modulation like OFDM use guard intervals, time interleaving and forward error correction techniques to reduce multipath interference and fading at the expense of data rate and time delay.)

Multipath reception, with its time-varying nature, can be described in statistics. The time-varying envelope of the received signal can be described by a probability density function.

In the case of a dominant signal with line of sight and additional reflections, the fading distribution is Rician. If there is no line of sight component, as it is often the case in urban areas, the fading distribution is Rayleigh. The latter is worse, with deep drops in the received signal level (see Fig.15).

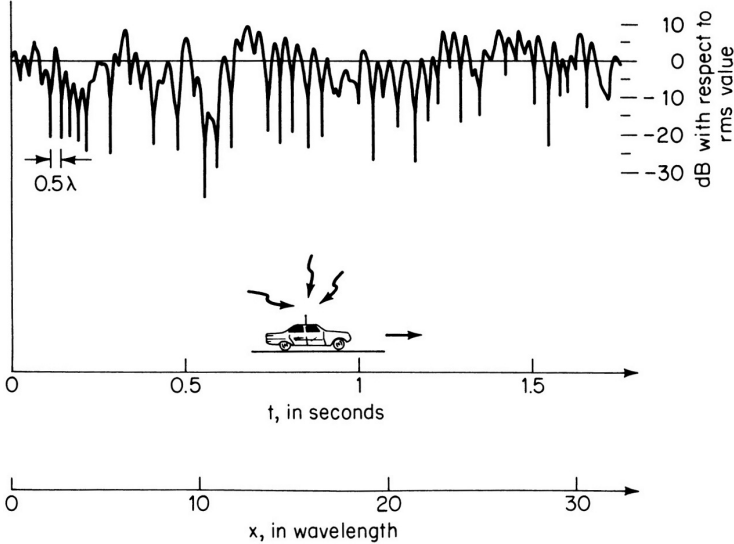

Figure 15
Rayleigh distributed signal envelope as a function of time [19]

Doppler effect

The Doppler effect has no measurable impact on reception quality, even at speeds of 160 miles/h.

Diversity techniques at the receiving site

There are various diversity techniques that can be used to improve the reception reliability and quality [20]. Diversity can avoid severe signal drops and can be seen as a threshold extension technique.

Diversity can be in frequency, space, or polarization. A distinction is made between antenna and receiver diversity. In general, at least two receiving possibilities are used to improve the receiving quality.

In case of frequency diversity, RDS within a receiver is used to switch to a better signal of another frequency with the same program.

Antenna diversity is reached with antennas at different locations or polarizations, ideally giving decorrelated receiving signals. With selective diversity, the antenna with the best signal quality is selected. In this case, some processing is required in the receiver. The processing can be a switching to, or selecting of another antenna, if the signal quality falls below a threshold.

If the selection process chooses one of the receiving branches that includes receivers, this is called receiver diversity. Selective diversity is relatively simple as it selects only one branch at a time. It shows acceptable results when it comes to avoiding deep fades. With FM, this keeps the signal above the FM threshold where the audio SNR is sufficiently high.

Diversity combining techniques

If different receiving branches behave independently, the probability of a deep fade occurring in all branches simultaneously is low. So individual receiving branches (characterized by, e.g. individual antennas and a signal evaluation in the receiver) can be combined in the receiver to improve signal-to-interference-plus-noise ratio SINR. Diversity combining techniques are:

- maximal-ratio combining (MRC)
- equal-gain combining (EGC).

MRC and EGC add the individual branch signals. To ensure coherent addition, the individual branch signals have to be in phase. This means a kind of branch signal analysis has to take place. EGC performs close to MRC without having to estimate the channel gain. With MRC, additionally, the individual gains of the branches are adjusted. Therefore, each branch has its own complex weighting function. With mobile reception, the weights have to be continuously adjusted to achieve maximum signal quality. I am not aware of any implementation of this technology with analog FM.

Receiver architecture

Standard receiver architectures are the superheterodyne receiver (superhet), the low IF and the zero-IF (or direct conversion) receivers. Modern receivers are digital. Analog-digital conversion (ADC) usually takes place in the RF or IF range. If parts of the signal processing are carried out by software (e.g. bandwidth limiting, FM demodulation or stereo decoding), this is called software designed radio (SDR).

References

- [1] *ITU-R BS.450*, Transmission Standards for FM sound broadcasting at VHF, https://www.itu.int/dms_pubrec/itu-r/rec/bs/R-REC-BS.450-4-201910-I!!PDF-E.pdf
- [2] Simon Haykin, *Communication Systems*, 3rd Ed., 1994, John Wiley & Sons, Inc., ISBN 0-471-57176-8, page 163, Eq. 3.74
- [3] W. David Gregg, *Analog & Digital Communications*, 1977, John Wiley & Sons, Inc., ISBN 0-471-32661-5, page 244, Eq. 7-148
- [4] W. David Gregg, *Analog & Digital Communications*, 1977, John Wiley & Sons, Inc., ISBN 0-471-32661-5, page 246, Eq. 7-153b
- [5] https://www.ofcom.org.uk/_data/assets/pdf_file/0013/54310/annex-f.pdf
- [6] https://www.itu.int/dms_pubrec/itu-r/rec/p/R-REC-P.372-14-201908-I!!PDF-E.pdf
- [7] Prof. Dr.-Ing. Dietmar Rudolph, *Vorlesungsskript "Modulation_Noise_WS_0506.pdf"* http://www.diru-beze.de/modulationen/skripte/SuS_W0506/Modulation_Noise_WS_0506.pdf
- [8] US patent *US 9,455,853 B2*, DEVICE AND METHOD FOR FM DEMODULATION WITH THRESHOLD EXTENSION
- [9] Karl Küpfmüller, *Die Systemtheorie der elektrischen Nachrichtenübertragung*, 4. Auflage, 1974, S. Hirzel Verlag Stuttgart, ISBN 3 7776 0248 5, page 287, Eq. 1112
- [10] US patent *US 10,003,422*, METHOD FOR PROCESSING AN FM STEREO SIGNAL
- [11] *BBC Research Department Report*, VHF-FM Radio Broadcasting: Tests to compare horizontal, vertical and mixed polarizations <http://downloads.bbc.co.uk/rd/pubs/reports/1986-13.pdf>
- [12] *ITU-R BS.412*, Planning Standards for terrestrial FM sound broadcasting at VHF https://www.itu.int/dms_pubrec/itu-r/rec/bs/R-REC-BS.412-9-199812-I!!PDF-E.pdf
- [13] *ITU-R BS.641*, Determination of radio-frequency protection ratios for frequency-modulated sound broadcasting https://www.itu.int/dms_pubrec/itu-r/rec/bs/R-REC-BS.641-0-198607-I!!PDF-E.pdf
- [14] *EBU-Tech 3236*, VHF/FM Planning Parameters and Methods. <https://tech.ebu.ch/docs/tech/tech3236.pdf>
- [15] *Report ITU-R BS.2213-4*, Impact of audio signal processing and compression techniques on terrestrial FM sound broadcasting emissions at VHF. https://www.itu.int/dms_pub/itu-r/opb/rep/R-REP-BS.2213-4-2017-PDF-E.pdf
- [16] *BBC Research & Development*, FM Radio: The calculation of distortion arising from multipath propagation <https://www.bbc.co.uk/rd/publications/whitepaper184>

- [17] Simon Haykin, *Communication Systems*, 3rd Ed., 1994, John Wiley & Sons, Inc., ISBN 0-471-57176-8, page 343, Eq. 5.62
- [18] Simon Haykin, *Communication Systems*, 3rd Ed., 1994, John Wiley & Sons, Inc., ISBN 0-471-57176-8, page 330
- [19] http://www.diru-beze.de/veroeffentlichungen/telekom/Digitalisierung_UKW_Bereich_1.pdf
- [20] J.D. Parsons, *The Mobile Radio Propagation Channel*, 2000, John Wiley & Sons, Inc., ISBN 0-471-98857-X